



# MACHINERY & SERVICES

TRANSFORMING TOGETHER







# Delivers reliability, quality, and trust across a range of industries.

Vitro was founded in 1909 and operates four business units that produce high-quality, innovative products and solutions that exceed our customers' expectations: Glass Containers (Cosmetic and Pharmaceutical), Architectural Glass, Automotive Glass, and Diverse Industries (Machinery & Equipment, Automation, Metal mechanics and Chemicals).

Our business units serve various markets and industries, from food and beverages to automobiles to commercial construction. Further, our commitment to sustainability in our operations, manufacturing processes, and product applications enables our customers and us to meet increasingly demanding environmental responsibility and performance goals.





# FAMA<sup>®</sup>: a Vitro<sup>®</sup> subsidiary

FAMA<sup>®</sup>, born in 1943 as Vitro's subsidiary for in-house machinery manufacturing has a proven track record of creating forward and innovative industrial technology.

Nowadays, we have increased our products and services to the market, in order to provide solutions for diverse industries.

Supporting by 80 years of experience manufacturing high-technology specialized machines and with eyes set on the future, we have extended to other industries besides Vitro to integrate projects that require a high technological capacity and infrastructure.



We at FAMA® transform the productivity of our customers to outstanding levels by gathering state-of-the-art technology and a highly committed workforce that allows us to form strategic alliances to provide integral solutions for diverse industries.





# Competitive Advantages



## Infrastructure

Our facilities allow us to be vertically integrated with areas that range from design & iron casting to machining.

## Transformation Culture

Highly qualified staff at every level of the organization constantly oriented to maintain a culture of transformation.

## Quality + Innovation

Wide range portfolio of products and services that revolve around innovation; with competitive prices, high quality standards and optimal lead times.



# Transforming together



1909

Vitro starts operations.



1943

FAMA® is born as the 'technological arm' of Vitro to provide machinery and equipment for the affiliate companies.



1944

The first foundry was built using a cupola furnace.



1946

The first two-section IS machine is produced to create new and more efficient machinery for the glass industry.

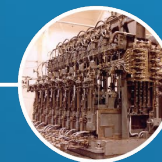

1950

Mold and machinery exports begin.

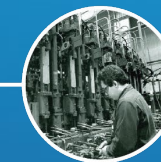

1970

Fabricación de Máquinas S.A. starts international operations.



1980

FAMA® joins the globalization process by becoming an exporting company.



2015

FAMA® expands its products and services globally, offering integral solutions for the glass industry.



2017

We expand our product and service portfolio into the market to offer integrated automation solutions in diverse industries.



2018

With 75 years of experience and the sight set on the future, FAMA® reaches out to other industries in the manufacturing sector.



2021

FAMA® expands its automation capabilities with the acquisition of Grupo Gersa Monterrey.



2023

FAMA® keeps growing and being a strategic partner offering machinery and services for the glass industry, metalworking and automation solutions.



# FAMA's Leadership Team



**Juan Farías**  
FAMA's  
Managing Director



**Alfonso  
García**  
Machinery  
Operations  
Manager



**Carlos  
Sandoval**  
Automation  
Operations  
Manager



**Victor  
García**  
HHRR  
Manager



**Lorena  
Casiano**  
Marketing  
Coordinator



**Roberto  
Delgado**  
Comptroller

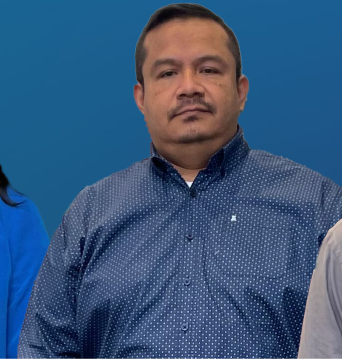

**Francisco  
Sada**  
Strategic  
Planning



**Armando  
Solís**  
Supplies  
Manager



# Machine Manufacturing's Leadership Team

**Alfonso García**  
Machinery  
Operations  
Manager

**Alejandro Saenz**  
Machinery  
Operations  
Manager

**Oziel Reyna**  
Head of  
Manufacture

**Ángel Vázquez**  
Head of  
Technical  
Assistance

**Mirna Leal**  
Head of Sales  
& Customer  
Services

**Endelia García**  
Head of  
Planning &  
Quality

**Luis Hernández**  
Head of Design  
& New Product  
Development

**Daniel Arredondo**  
Head of  
Electronics &  
Technology

**Antonio Rocha**  
Head of  
Foundry





# Commercial Team

**Juan Farías**  
Managing Director



## Machinery & Foundry

**Alfonso García**  
Operations Manager



**Mirna Leal**  
Head of Sales & Customer Services



**José Fuente**  
Machinery Sales



**Heriberto Garay**  
Machinery Sales



**Katia García**  
Customer Service



**Armando Galván**  
Machinery Sales



**Hector Carrillo**  
Customer Service



**Dennis Manzanares**  
Customer Service



**Ricardo Tenorio**  
Iron Casting Estimator



**Adrián Hernández**  
Iron Casting Sales



# Machinery & Services

We develop engineering technologies to improve productivity and reduce defective and downtime rates. As a result, our machines achieve an efficient and high-quality process in producing glass containers, providing higher profitability for our customers.

## IS Machines

- FMDE
- FMVE
- FMPR

## Spare Parts

- Basic Mechanisms
- Variable Equipment
- Modular Sections
- Conversion Kits

## R&D

- Full Servo
- Control CEIS

## FAMA Services

- IS Machine condition evaluation
- Maintenance (Kits & services)
- Mechanism repair and replacement
- Modular Sections
- Refurbished machines
- IS Machine Installation
- Technology integration
- Analysis and simulations
- Specialized Engineering services





# IS Machines

# FMPR

- **Productive** IS machine with Quadruple Gob: 3 ¾", 4", 3 ¾", between cavities with conversion into 5" TG. It has the ideal characteristics to produce BB and NNPB containers.
- Servo gob distributor of one motor per cavity to perform at maximum precision in the gob delivery.
- Equipped with Servo Invert and Servo Takeout for better product handling during the forming process.
- Axial cooling on the mold side and blank side to improve temperature control that provides lighter containers and increases speed
- "Closed loop" process control system for production and quality critical variables.

# FMDE

- DG 4 1/4" traditional "E" IS machine with conversion into SG, focused on a **detailed** production.
- This machine model has its own 3 1/2" TG version.
- The wide manufacturing range and variable equipment simplicity make this machine an excellent option for short runs or frequent mold shifts.
- Versatility to work on BB, PB, and NNPB processes
- It can be equipped with a pneumatic mechanism or Servo Invert and Servo Takeout mechanism
- The essential machine section can be equipped from the most basic level to the highest technological advances for the NNPB process control

# FMVE

- TG 4 ¼" **versatile** high-speed IS machine with conversion into DG 6 ¼" and SG. It has the ideal characteristics to produce glass containers in BB, PB, and NNPB.
- It can work with Axial Cooling in TG and DG.
  - This enables mold cooling during the 360° machine cycle, thus increasing the high productivity.
  - Improves blank temperature control giving, as a result, lighter containers and higher machine speed
- TG, DG, and SG universal Blank Mold Support that reduces the time of conversion system
- Equipped with Servo Invert and Servo Takeout mechanisms
- Tested "closed loop" process control system for critical variables of quality and production
- Delivery equipment and gob distribution system of proven efficiency developed for better alignment and gauging.



# FMPR

QG

TG

11 ½"

10"

BB/PB  
NNPB

BB/PB  
NNPB

10, 12

# FMDE

TG

DG

SG

3 ½"

4 ¼"

-

BB/PB  
NNPB

BB/PB  
NNPB

BB/PB

6, 8, 10

# FMVE

TG

DG

SG

4 ¼"

6 ¼"

-

BB/PB  
NNPB

BB/PB  
NNPB

BB/PB

2, 4, 6, 8, 10

# FMPR

# FMDE

# FMVE

393 mm Max. height S.G. and D.G.

355 mm Max. height S.G. 4 1/4"

350 mm Max. height T.G. 10"

304 mm Max. height T.G. 4 1/4"

285 mm Max. height D.G. 4 1/4"

247 mm Max. height quad. 1 1/2"

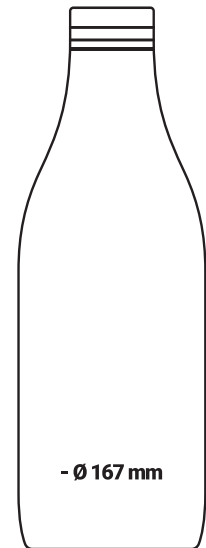
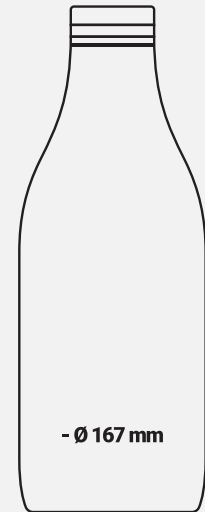
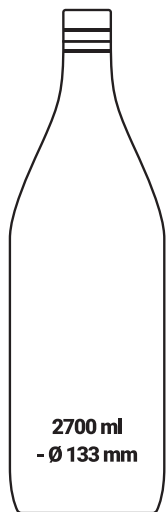
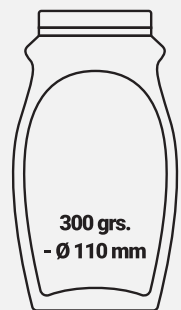
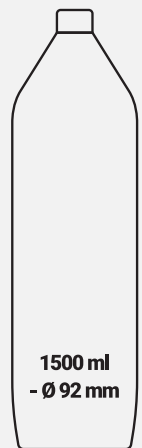
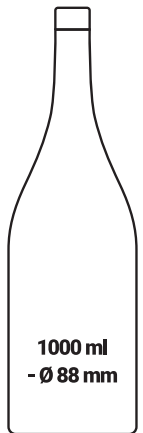
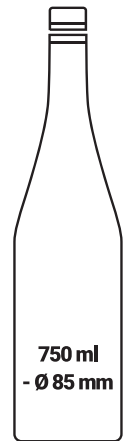

Prod. range quad. 1 1/2"

Production range for D.G. 6 1/4"

Production range for D.G. 4 1/4"

Production range for S.G. 4 1/4"

Production range for T.G. 4 1/4"

Production range for D.G. 6 1/4"

Production range for S.G.



# Spare Parts



# Basic Mechanisms

			
<b>Reinforced Open and Close</b>	<b>Pantographic Baffle</b>	<b>Neck Ring</b>	<b>Pneumatic and Servo Takeout</b>
			
<b>Universal Axial Blank Mold Support</b>	<b>DG/TG convertible Plunger Cylinders</b>	<b>Pneumatic and Servo Invert</b>	<b>Bottom Plate</b>
			
<b>Axial Blow Mold Support</b>	<b>Funnel</b>	<b>Blow Head</b>	<b>Servo Gob Distributor</b>

# Variable Equipment

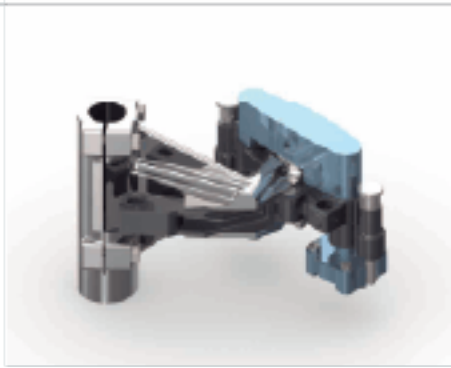

**Pantographic Baffle Arm**

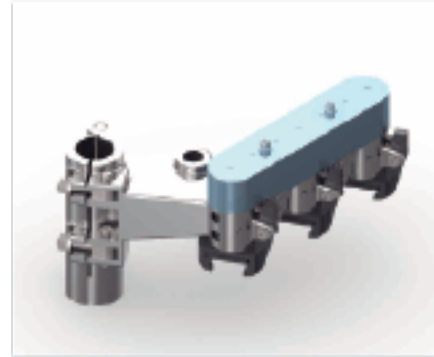

**Blow Head Arm  
with finish neckring cooling**

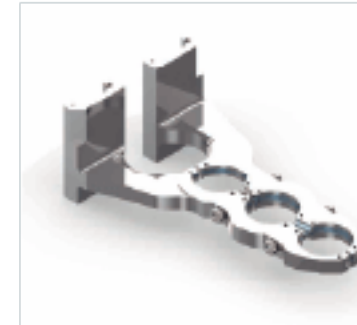

**Neck Ring Holder Arm**



**Funnel Arm**

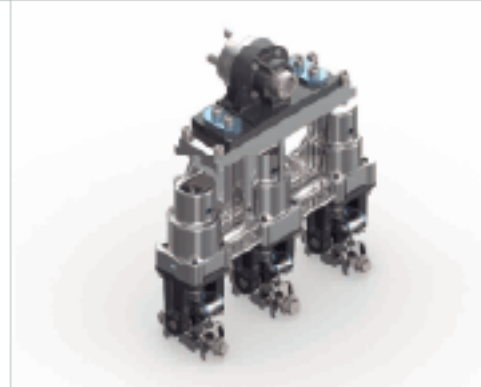

**Takeout Tong head**



**Bottom Plate Holder  
with cooling and vacuum**



# Cooling Systems

## Blank mold

## Blow mold

### Holder's arm

- Reinforced for a reliable and resistant operation.
- SG, DG, TG and QG cooling control.
- "Axial" cooling for quadrant control and "Cage" cooling for side control.
- Manufactured with high resistance interchangeable pieces to extend operation effectivity and make maintenance easier.

- Reinforced for a reliable and resistant operation.
- Designed with high resistance interchangeable pieces for an extended efficient operation.
- It has specific airway passages for a uniform cooling distribution for each cavity.

### Cooling

- The development of a universal bracket allows using different holder assemblies and cooling systems.
- Cooling is available during the 360° of the machine cycle.
- The operation with automatic blanks temperature control provides stability for high-quality containers.
- The effectiveness and management of these cooling mechanisms ensure high production speeds.

- DG, TG, and QG have proven high speed and efficiency.
- Cooling is available during the 360° of the machine cycle.
- We provide technical assistance for thermal analysis in mold design and simulators for glass distribution.

# Conveyor

90° servo pushers of one and two axes to satisfy the requirements of speed and management precision, thus reducing equipment maintenance.

Dead plate conveyor features: air infeed timing and regulation, air lead (container and belt), and height gauging adjustment.

**7" width silent chain.**



# Handling Equipment



# Servo Transfer

The transfer paddles are designed for easy replacement. They are manufactured with high-quality and resistant materials to avoid checks on the products.

There is a wide variety of chains with spaces of 3", 4 ½", 5 ¼", 6", 6 ¾", 9", and 12" in left and right deliveries.

# Cross Conveyor

Sturdy design and equipment to provide leveling with the conveyor.

Arranged to provide horizontal alignment between the conveyor and the furnace, compensating for any misalignment that the furnace's heat could cause.

Easily replaceable, high-resistance transfer plates that provide better management at the lehr entrance and prevent falls.

Available width chains: 7", 8", 10", 12", and 14".

# Stacker

Designed to operate on a wide speed range.

Its sturdy construction minimizes the stacker beam vibration, aiding in better bottle handling.

# 144 Feeder

- SG and DG 4 3/8" C.D.
- Tube mechanism diameter: 5", 6", 7", and 8".
- 360° differential drive
- Shear mechanism: angular
- Capacity: up to 60 tons/day



- SG and DG 4 3/8" C.D.
- Tube mechanism diameter: 7"
- 360° differential drive
- Shear mechanism: angular
- Capacity: up to 110 tons/day

# 111 Feeder

# Feeder 194

- SG and DG 4 3/8" C.D.
- Tube mechanism diameter: 7"
- 360° differential drive
- Shear mechanism: angular
- Capacity: up to 70 tons/day

- SG and DG 4 3/8" C.D and T.G. 3" C.D.
- Tube mechanism diameter: 10" and 11"
- 360° differential drive
- Shear mechanism: angular and parallel
- Capacity: up to 168 tons/day

# Feeder 151

**R&D**

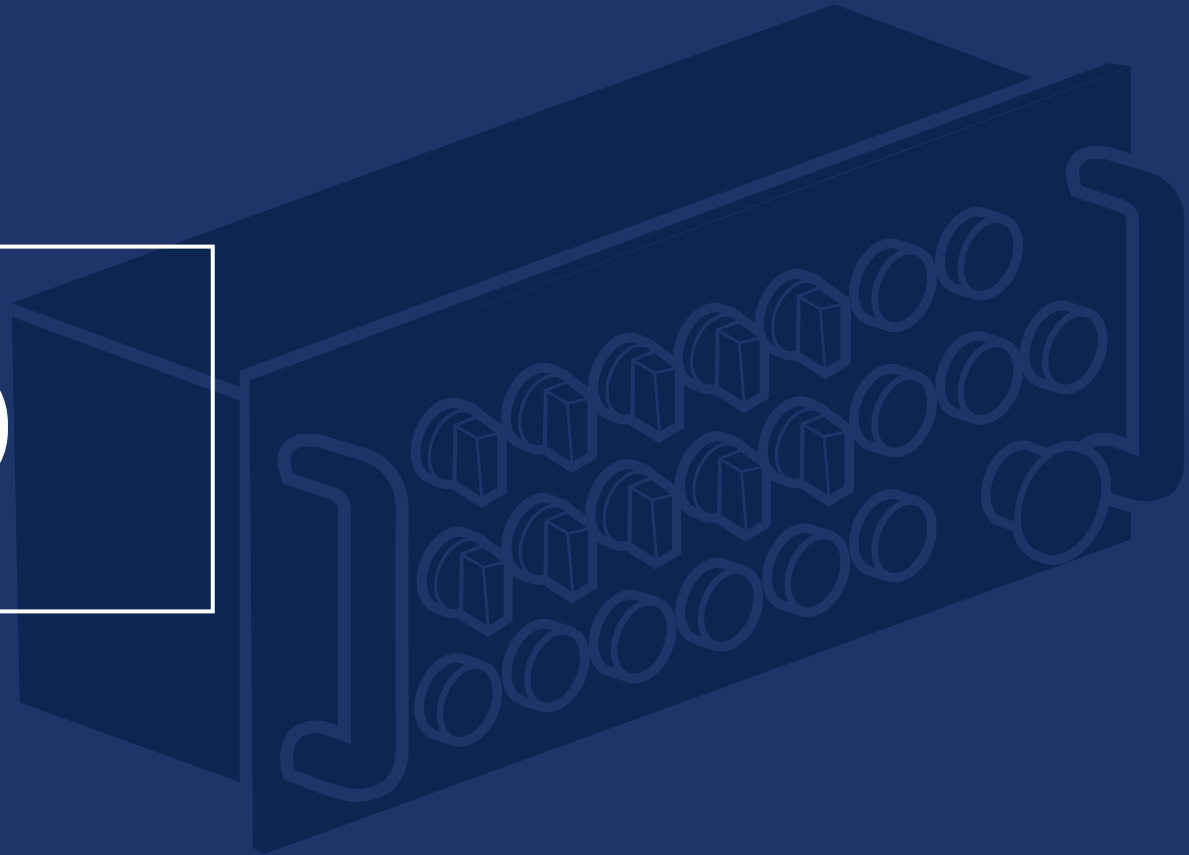



# CEIS Variations:



## Economic benefits

- Increases mechanisms lifetime
- Reduces downtime
- Reduces damages on molds
- Reduces damage on variable equipment

CEIS-N:

IS Machines 100%  
pneumatic

CEIS-3:

IS Machines with  
3 servos per section

CEIS-9 (Full Servo):

IS Machines with 9 or  
more servos per section.

## Process and operation benefits

- Pack to melt increase
- Glass container manufacturing time reduction
- Servo mechanism sequences optimization
- Supports efficient job change and processes
- Aids new product development processes

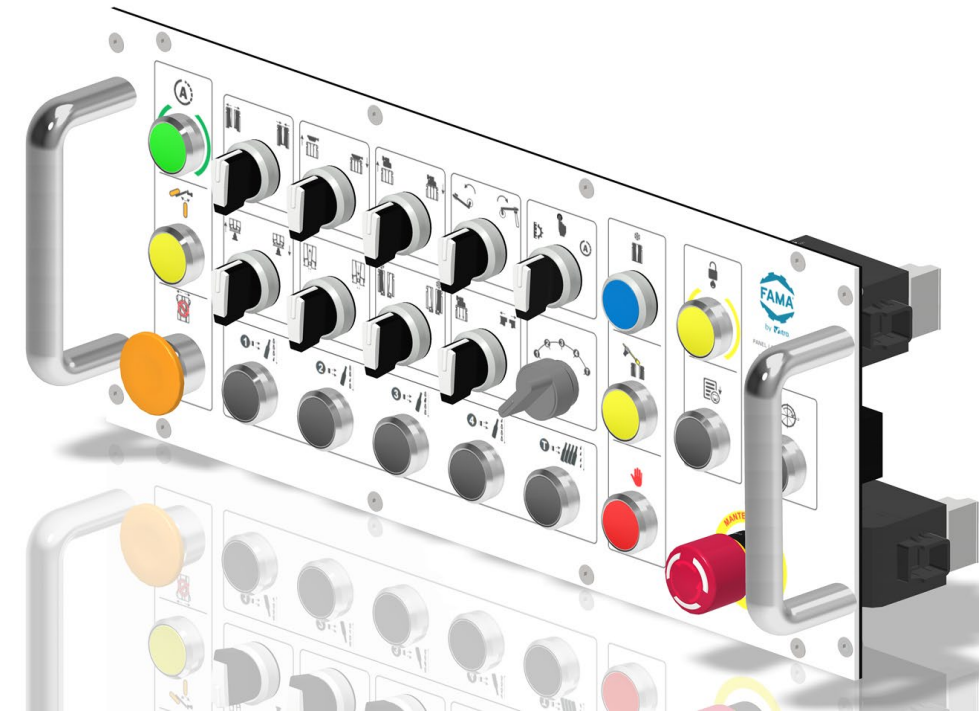



## Configurable

- Control from the feeder to the stacker
- Up to 12 sections operation
- User friendly interface
- Process standardization of using expert systems
- Reliable operation by intelligent adjustments in containers forming history

## Operation flexibility for each process and high operation performance

## Productivity increase:

- Unique algorithms for innovative speed changes
- Efficient setup in mold and process changes

## Reliable operation in the intelligent adjustments (timing) in the container forming history



## Intelligence

---

- Predictive information for the operator
- Automatic generation of work histories/recipes (time and degrees)
- Fine adjustment in work histories/recipes for ceramic cycle and process times
- Forming process limits and mechanical interferences forecasts
- Innovative speed changes (CPM) in 3 levels
- Operative diagnostic for maintenance
- IS machine production statistics (meters for manufactured glass containers, rejects, and production time)

## Advantages

---

- Personalized to operate in times or degrees (graphical and numerical)
- Graphic adjustment (directly through the graphics)
- Optimization of machine speed in three levels
- Servo mechanisms smart motion cams
- Conversion of manufacturing history and measurement units (degrees to units of time and vice versa).
- Configuration
- Availability to export data for statistical analysis at each variable of "N" sections

## Servo gob distributor (Multi-axis)

---

- Independent servomotors control from 1 to 4 cavities
- Capacity to operate up to 12 sections in IS machines
- Maximum operation speed of 220 CPM
- Excellent operation stability, high precision, and repeatability in the scoop positioning
- This achieves an efficient delivery from the gob to the IS machine
- Practical, simple operation for the user

## Electronic gob distributor panel

---

Panel for:

- Startup
- Stop (normal or for maintenance)
- Reference (home)
- Jogging
- Calibration
- Record positions of the distributor once they are aligned with the delivery equipment
- Gob rejection

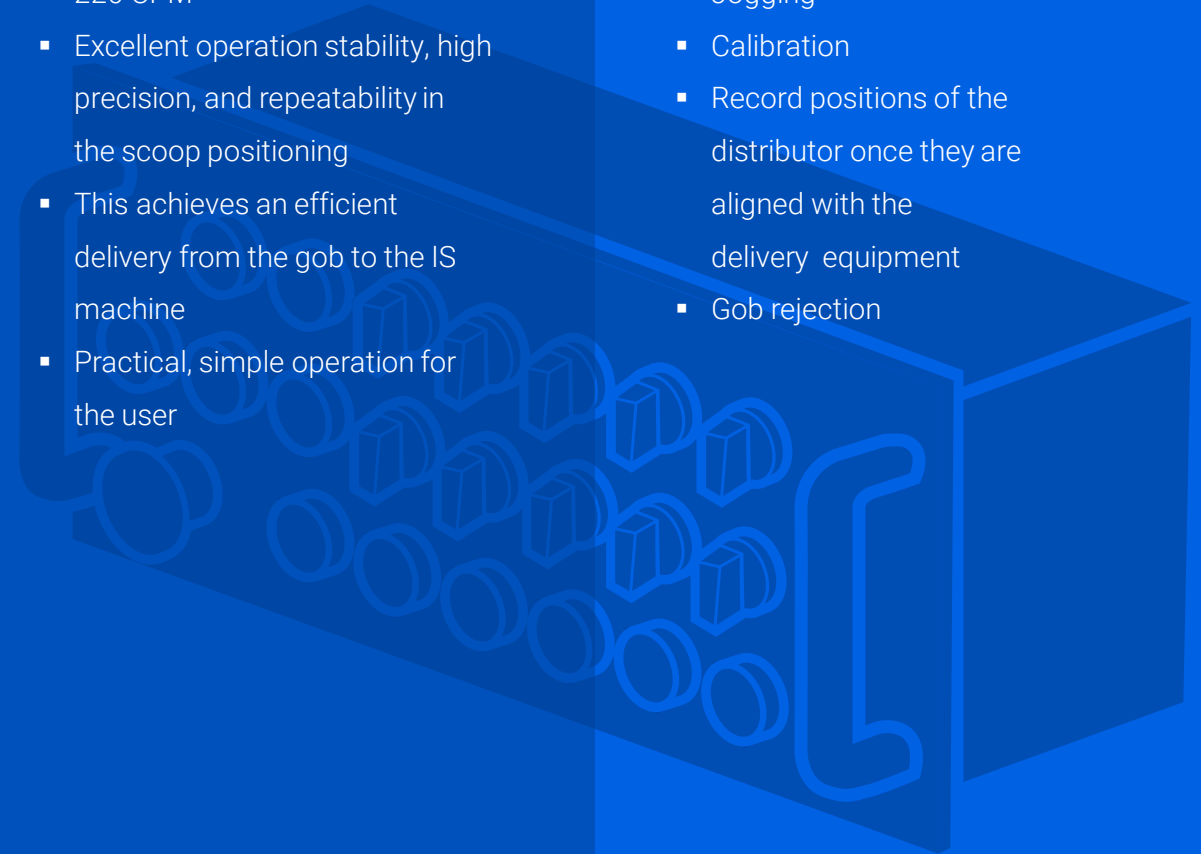

# Operator assistant

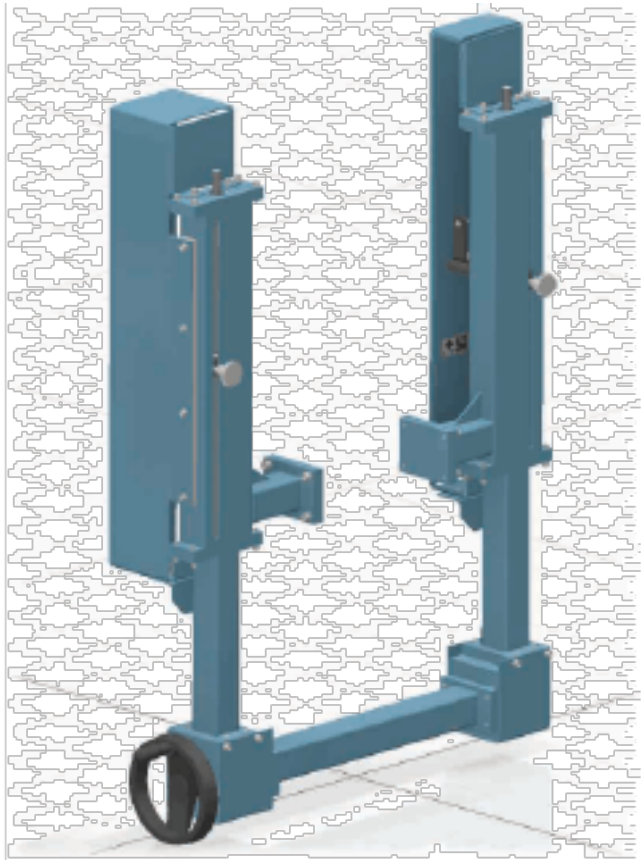

**Electronic system that automatically detects and rejects containers that have fallen and/or got stuck on the conveyor.**

**High precision due to a particular device and intelligent algorithms.**

Ability to:

- Operate in tandem IS machines
- Detect 880 containers per minute
- Interconnect with any external technology and be self-supported
- Integrated to CEIS
- Self-learning from the operation setup data
- Generate statistical data
- Provide an easy and effective diagnosis
- Fast and simple maintenance

## Advantages

- Accurate and continuous monitoring of containers
- Timing of the container's rejecter for each section and cavity is quickly and automatically achieved
- Self-adjusting to the variations of the position of the container on the conveyor belt
- Efficiency and safety on the line are improved due to the risk reduction of containers being stopped on the conveyor belt.
- Reduction in the operator workload that allows the operator to spend more time monitoring and supervising the forming process
- Easy setup configuration



# Process manager

The human-machine interface of the CEIS, where the operator sets up, supervises, and modifies the process and operation parameters.

It has software targeted to improve the container formation processes and is prepared for Industry 4.0.

# Main components

- Server
- Kiosk
- HMI Wireless

# FAMA 4.0

**FAMA develops its machinery using next-generation electronic equipment, which natively has the components needed for Industry 4.0.**

## Advantages

- Intelligent interface with numerical and graphical adjustments
- Accessible, intuitive data for the operator
- Configurable to manufacturing processes requirements
- Forming process limits and mechanical interferences forecasts
- Unique algorithms to achieve intelligent speed changes (CPM) in IS machine (in teacher or follower modes)
- Interconnection with different technologies
- Links the automation with the needs of the operator
- Displays information for operative diagnosis and electronic maintenance, alarms, reports, process records, and all changes made in each of the signals and variables involved in the container manufacturing process
- Capacity to handle significant data volumes, parameters, maintenance, operation diagnosis, and work histories
- Server: Performance in operation and communication “all at once” to the machine (kiosk and HMI Wireless)
- Kiosk: Interface in the cabinet on the production line zone

# FAMA Services

**01**  
IS Machine  
condition  
evaluation

**02**  
Maintenance  
(Kits and  
services)

**03**  
Mechanisms  
repair and  
replacement

**04**  
Modular  
sections

**05**  
Refurbished  
machines

**06**  
IS Machine  
installation

**07**  
Conversion  
Kits

**08**  
Technology  
integration

**09**  
Analysis and  
simulations

**10**  
Specialized  
engineering  
services

# 01

## IS Machine condition evaluation

IS Machine evaluation to avoid production downtime due to damaged equipment conditions.

We offer complete equipment status reports and possible solutions to improve, and increase IS machines' operational profit and lifetime.

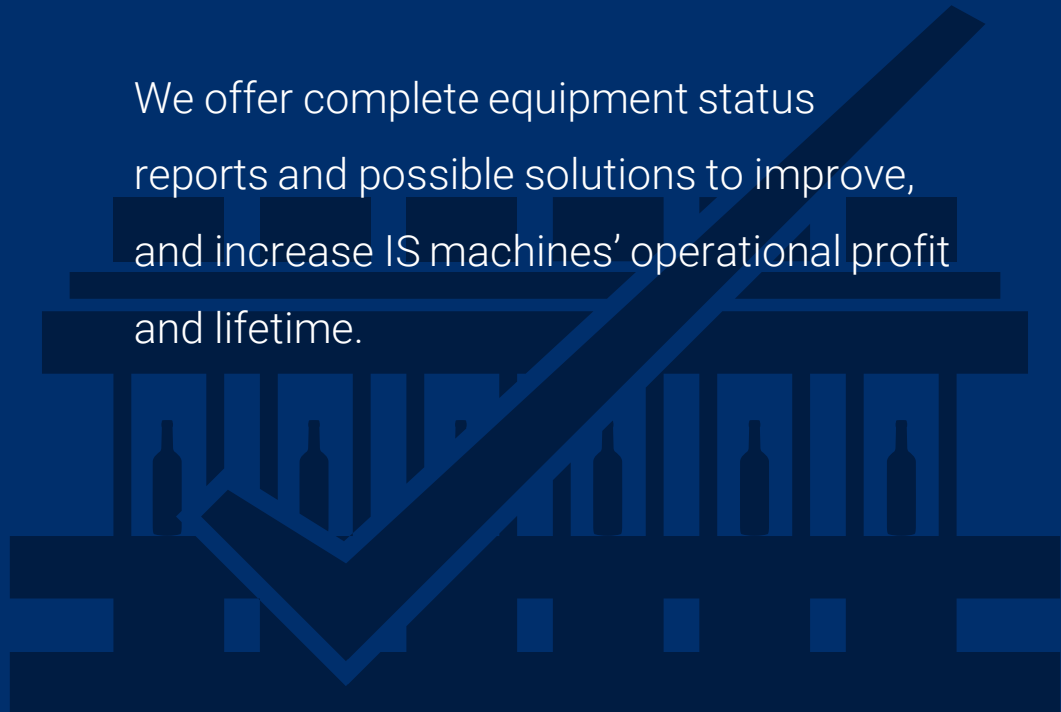

# 02

## Maintenance (kits and services)

In FAMA<sup>®</sup>, we offer IS Machines maintenance services, no matter whether it's FAMA technology or another brand.

- Minor
- Major

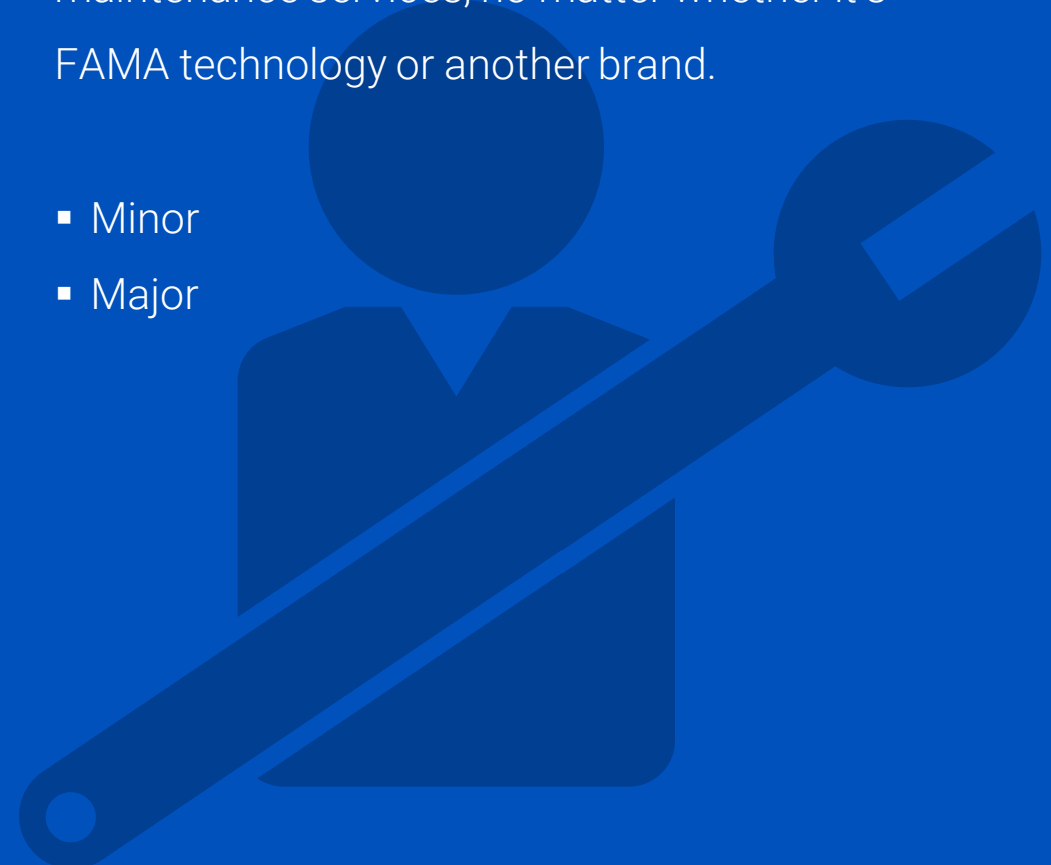

## 03 Mechanisms repair and replacement

- Mechanism repair; replacement of worn parts and total change of commercial spare parts.
- All parts are under quality inspection to ensure no component is reused out of specification.

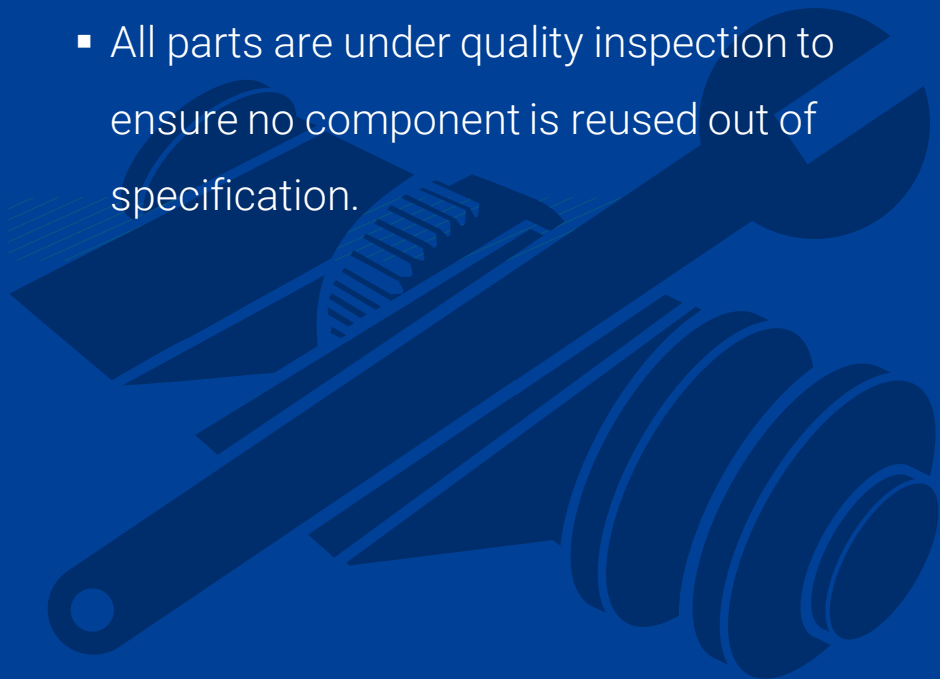

## 04 Modular sections

During the modular section maintenance process, existing sections are removed and replaced with new sections, and at the same time, basic mechanisms are replaced with new ones.

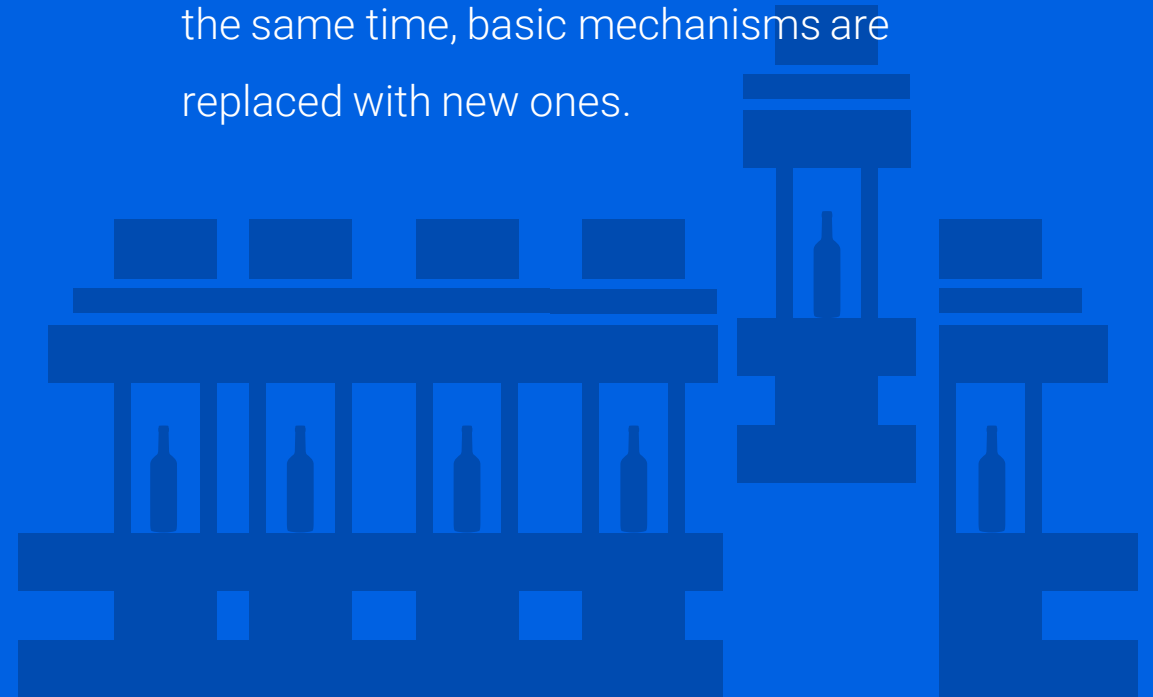



# 05

## Refurbished machines

We refurbish IS Machines extending their lifetime.

Refurbished services for FAMA / other technologies

- IS Mechanisms repair shop center
- IS Mechanisms maintenance kits
- Reverse engineering

# 06

## IS Machine installation

Our broad experience in the glass container industry allows us to offer IS Machine installation services, regardless of it is FAMA or other technologies.

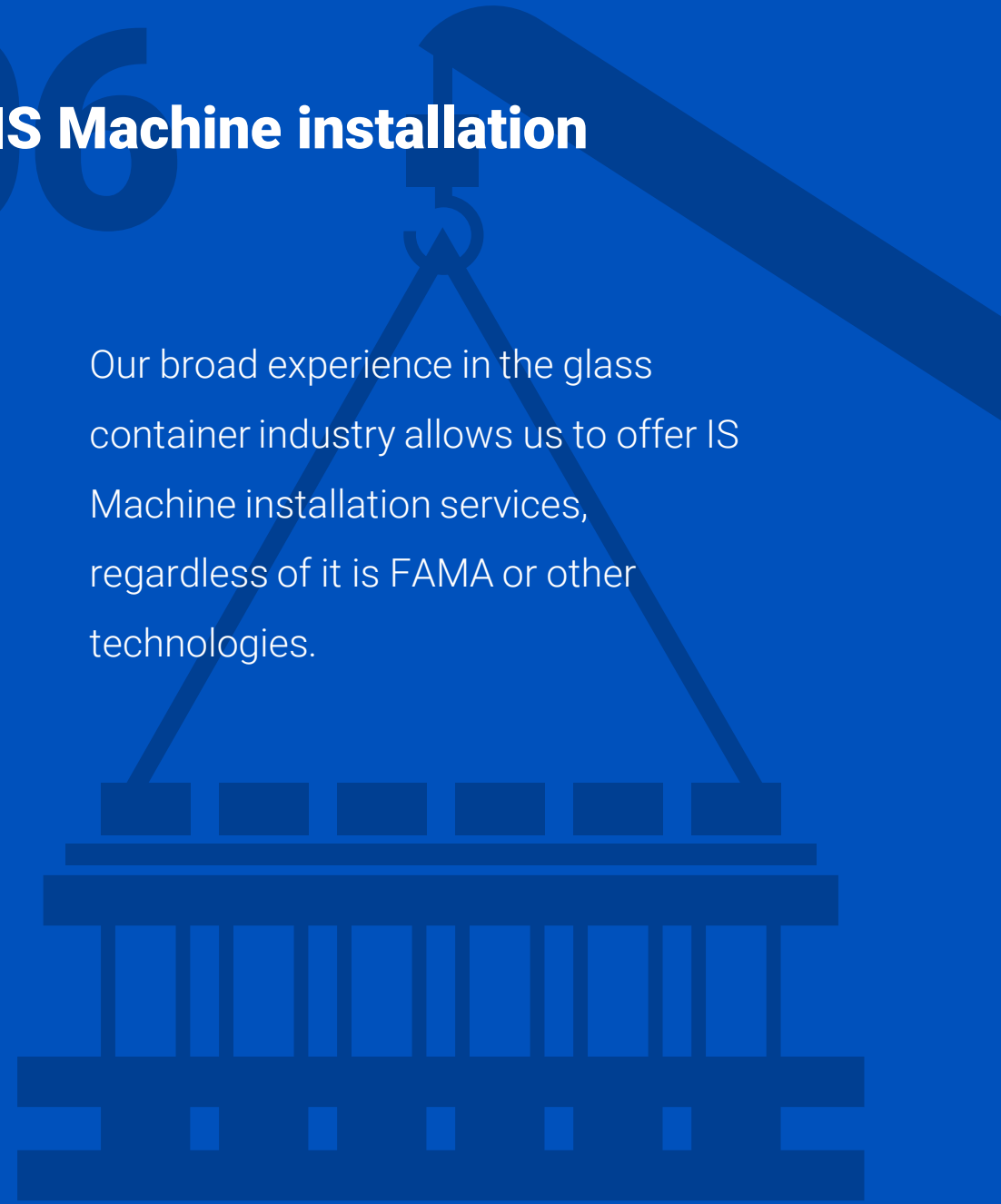

# 07

## Conversion kits

We manufacture FAMA technology systems and process conversion kits, offering kit installation regardless of it's FAMA or other technologies.

### Process

- Blow Blow (BB)
- Press Blow (PB)
- Narrow Neck Press Blow (NNPB)

### Systems

- Simple (SG)
- Double (DG)
- Triple (TG)
- Quadruple (QG)

# 08

## Technology integration

Our machines can be developed by integrating third-party technologies to satisfy the specific needs of our customers.

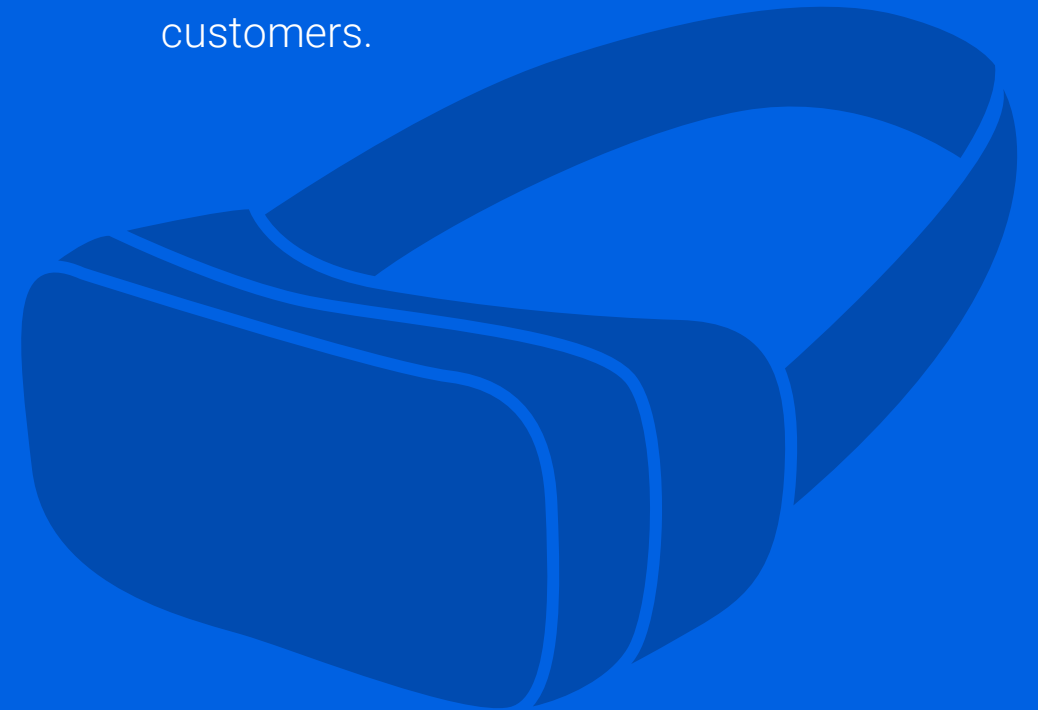

# 09

## Analysis and simulation

We have advanced engineering techniques for machinery and software specialized in 3D systems.

### We perform analysis and simulations specialized in:

- Mechanism kinematics (CAE)
- Fluid flow (CFD)
- Thermal / Structural mechanics (CAE)

### We have the capacity to simulate the pre-formed thermo, thickness prediction, and structural analysis

- Thermal & fluid analysis
- Structural analysis
- 3D Simulation
- Internal pressure
- Analysis

# 10

## Specialized engineering services

Development of customized engineering for specific customer solutions.

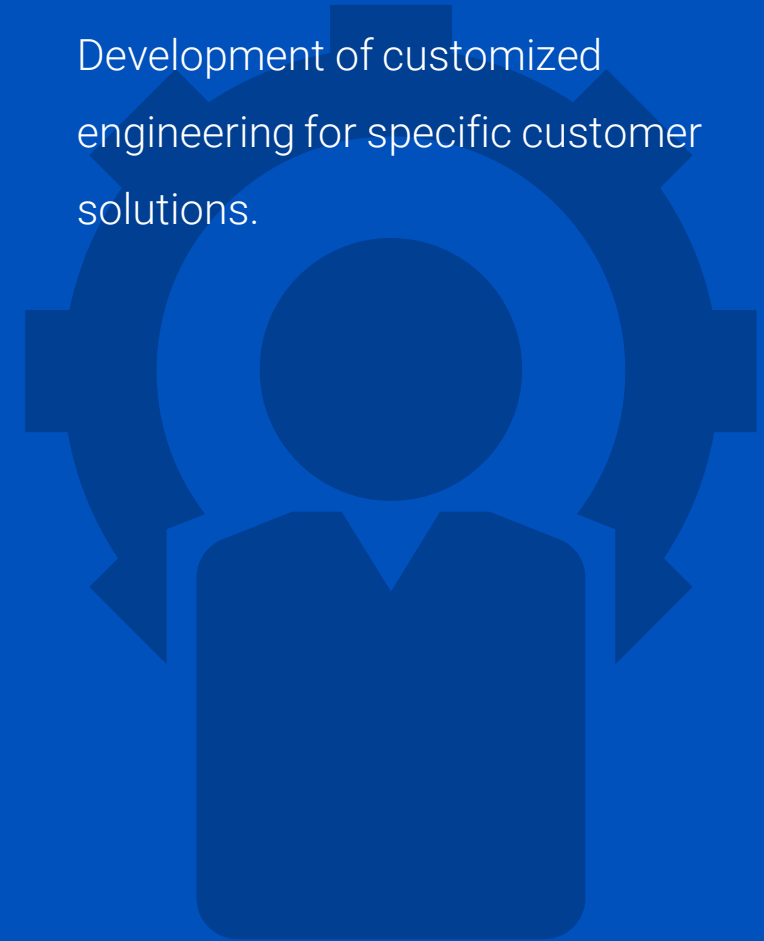

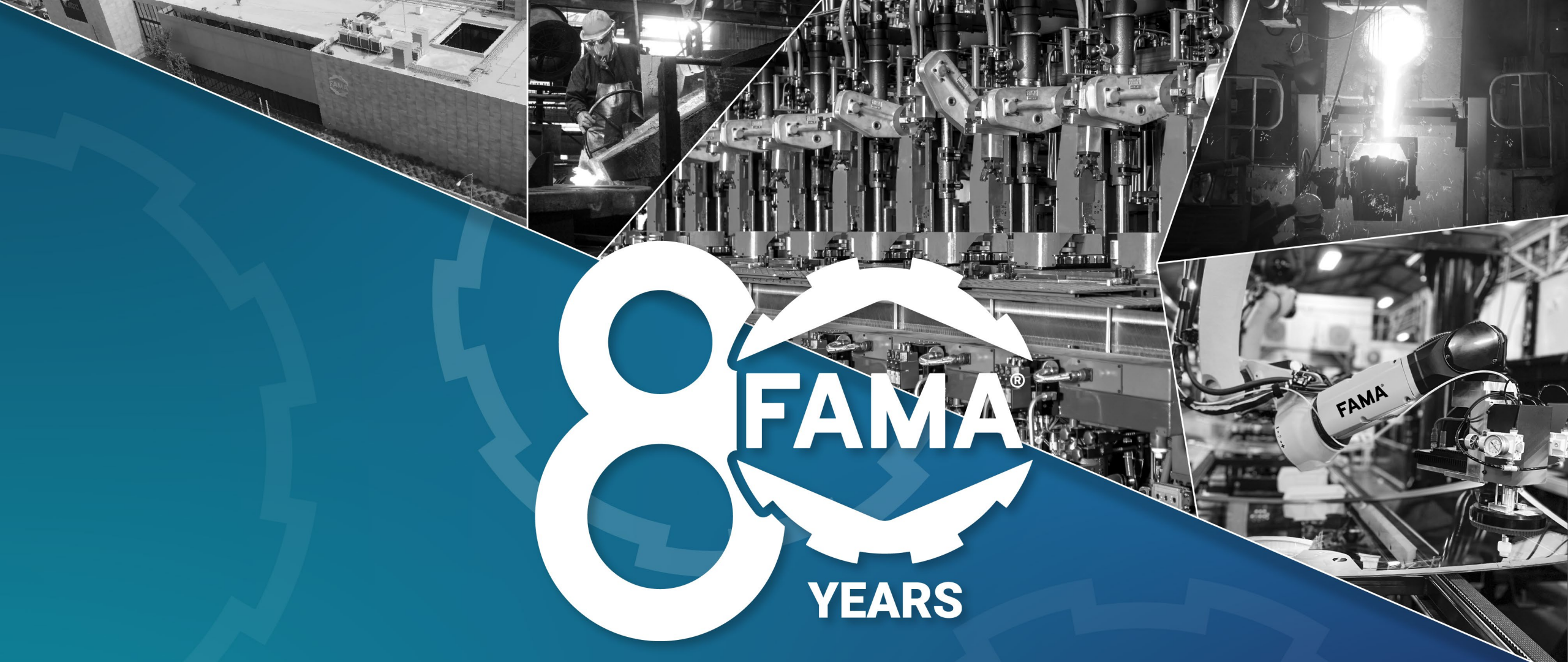

# 8 FAMA<sup>®</sup> YEARS



Follow us!  
**FAMAbbyVitro**

Keramos 225, Col. Del Prado 64410  
Monterrey, Nuevo León, Mx.

Tel. +52 (81) 8863 2800  
email. [ventasfama@vitro.com](mailto:ventasfama@vitro.com)

[fama.com.mx](http://fama.com.mx)